



Model 80 a 100



Model 120



Model 80 a 100

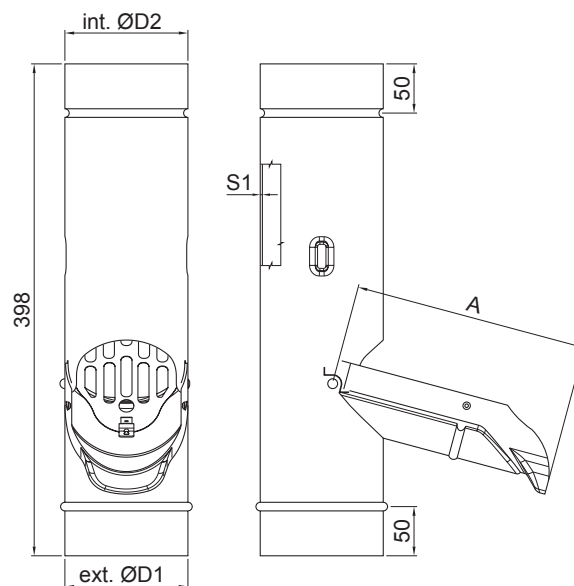



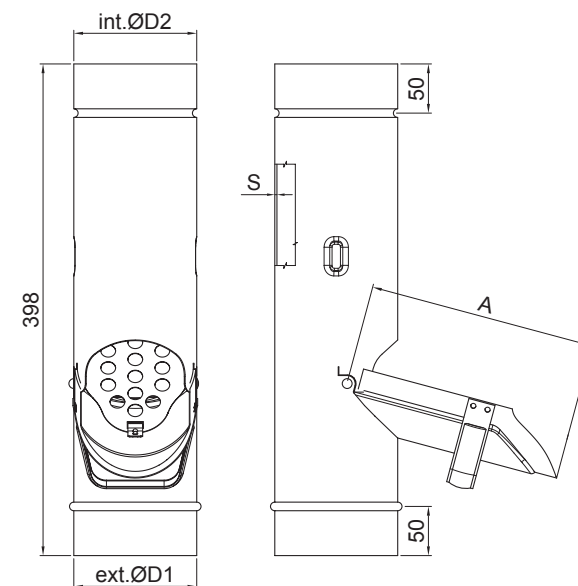





Model 120









Menovité rozmery (mm)	80	100	120
S1	0,70	0,70	0,70
A	150	190	230
ØD1	80	100	120
ØD2	80	100	120

Pre presné spojenie a kompatibilitu s existujúcimi žľabmi, zvodovými rúrami a príslušenstvom, je potrebné, aby boli dodržané rozmery podľa údajov STN EN 612.

Artikel – Objednávkové číslo W–HZVS * PRÉMIUM 80, 100

Menovitý rozmer (mm)	80	100	120
● Hliník EN AW–1050A H24, S1=0,70mm	●	●	●
 Objednávkové číslo	8584074035196	8584074035202	8584074035219
 Balenie kartón	 / 8 ks	 / 5 ks	 / 3 ks
 Balenie paleta	 / – ks	 / – ks	 / – ks

KJG DESIGN – Hliníkové zachytávače vody so sítom

 3D – náhľad	 Produktový prospekt web
 Technický list o produkte	 Objednávkové číslo
 Montážny list	 Balenie